

CycleGard®





CG450 Series
CGT450 Series

with SMARTCYCLE

Low Water Cut-Offs
For Steam Boilers

120 VAC Operating Voltage
Max. Pressure 15 psi

U.S. Patent No. 5,739,504

-  Low maintenance. No moving parts to wear stick or hang up, as in float devices.
-  Solid state circuitry. Designed for the highest level of performance and reliability.
-  Automatically shuts off burner, after delay, in a low water condition to prevent dry firing.
-  Time delay allows water to feed above the probe to a safe operating level.
-  INTERMITTENT LEVEL TEST – periodically monitors settled water level for added protection of today's smaller steam boilers.

HOW TO INSTALL

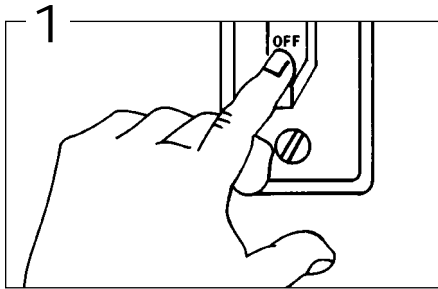

WARNING – To prevent electrical shock or equipment damage, power must be off during installation or servicing of the control. To prevent serious burns, the boiler should be thoroughly cooled before installing or servicing control. Only qualified personnel may install or service the control in accordance with local codes and ordinances. Read instructions completely before proceeding.

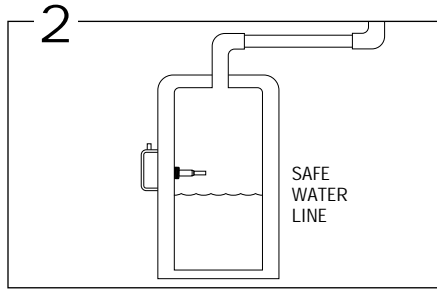

The probe may be installed in the boiler above the lowest safe water level established by the boiler manufacturer. Most manufacturers provide a suitable opening in the side of the boiler.

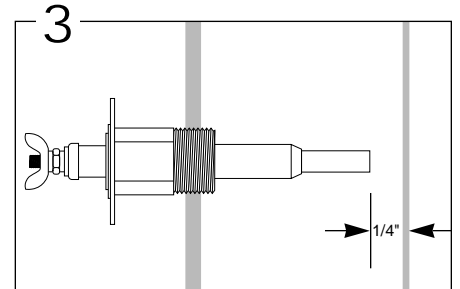

Allow 1/4" clearance from the probe to any boiler surface, tube or baffle. NOTE: Excessive use of Teflon tape to seal probe piping threads may insulate the control from boiler ground. This could result in the control not operating.

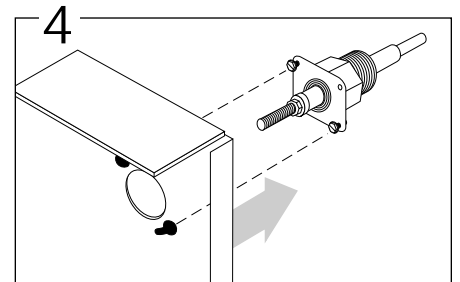

Loosen the two control cover binding head screws and remove the cover. Assemble the chassis to the probe flange and secure with the screws provided with the probe.

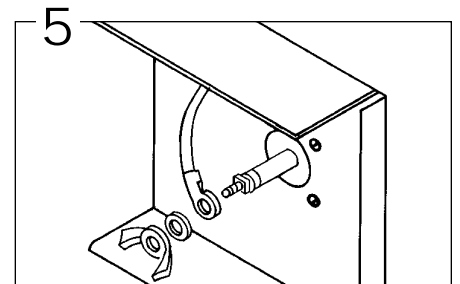

Connect the ring terminal wire lead to the probe terminal stud and secure with the lock washer and wing nut provided. With the power removed, proceed with installation and wiring according to the instructions on page 2. Upon completion of wiring replace control cover.

REMOTE MOUNTED MODELS ONLY

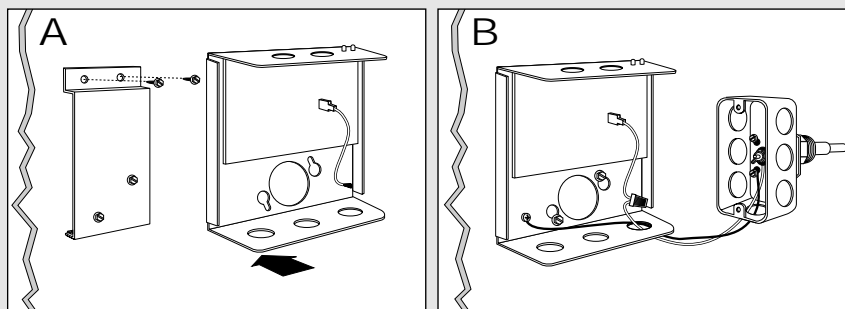

A. To secure mounting plate to boiler jacket,* pre-drill two 3/32" pilot holes using the mounting plate as a template. Secure plate with sheet metal screws provided. Attach control to mounting plate by slipping keyholes in back of chassis over pre-mounted screws on plate. Tighten screws.

B. Using a wire nut, attach a wire (min 90°C) to the pigtail lead in the control box. Attach the other end to the probe terminal in the remote probe housing. Attach a second wire between the ground screw on the control chassis and one of the four screws in the remote probe housing. Note: Wires and wire nuts not provided.

*Or other suitable surface

**HYDROLEVEL
COMPANY**

P.O. Box 1847
New Haven, CT 06508
Phone: (203) 776-0473
FAX: (203) 773-1019

HOW TO WIRE

MODEL CG450

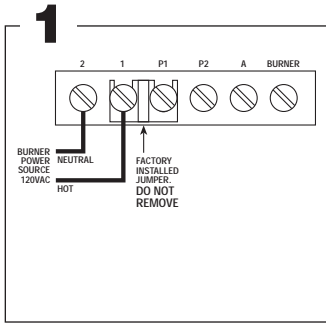

Connect input voltage (120 VAC, 60 Hz) to terminals 1 and 2.

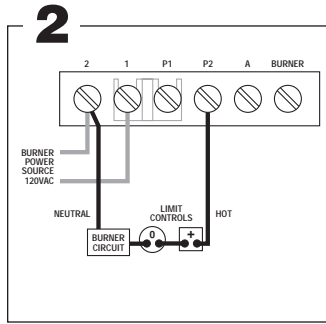

Connect terminal 2 to burner circuit neutral. Connect terminal P2 to burner Circuit in series with other limit controls. Consult boiler manufacturer instructions for proper terminal connections. Control should be wired in series with and before other limit controls.

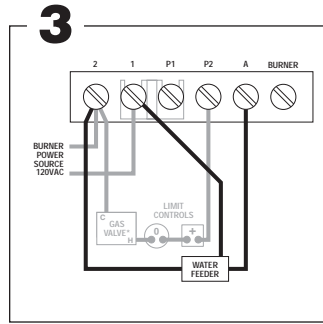

Optional water feeder connection. Connect feeder N to terminal 2. Connect Feeder H to terminal 1. Connect feeder "FEED" or "W" to terminal A. For water feeders with 2 leads, connect feeder neutral to terminal 2 and feeder hot to terminal A. **Note:** Use of a solenoid valve or McDonnell & Miller Model 101A water feeder may cause flooding and is not recommended for use with this low water cut-off.

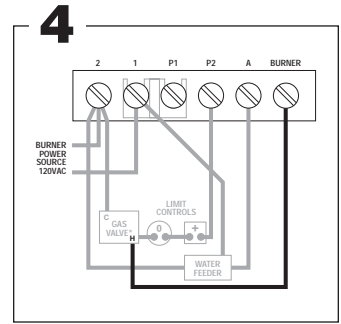

SMARTCYCLE OPTIONAL ACTIVATION
Connect "BURNER" terminal on the CycleGard control to the orange burner wire (120VAC) located under the oil burner transformer. See opposite page for schematic wiring diagram and additional SmartCycle description.

MODEL CGT450 (for boilers with tankless coil)

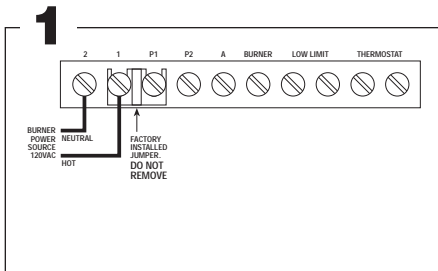

Connect input voltage (120 VAC, 60 Hz) to terminals 1 and 2.

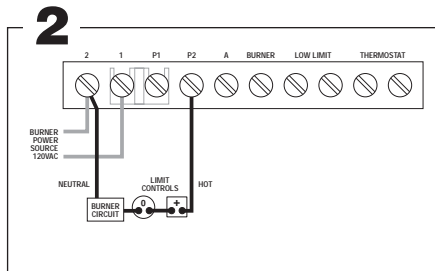

Connect terminal 2 to burner circuit neutral. Connect terminal P2 to burner Circuit in series with other limit controls. Consult boiler manufacturer instructions for proper terminal connections. Control should be wired in series with and before other limit controls.

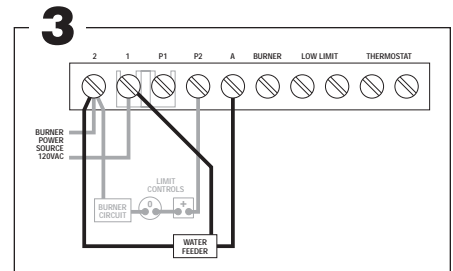

Optional water feeder connection. Connect feeder N to terminal 2. Connect Feeder H to terminal 1. Connect feeder "FEED" or "W" to terminal A. For water feeders with 2 leads, connect feeder neutral to terminal 2 and feeder hot to terminal A. **Note:** Use of a solenoid valve or McDonnell & Miller Model 101A water feeder may cause flooding and is not recommended for use with this low water cut-off.

SMARTCYCLE OPTIONAL ACTIVATION

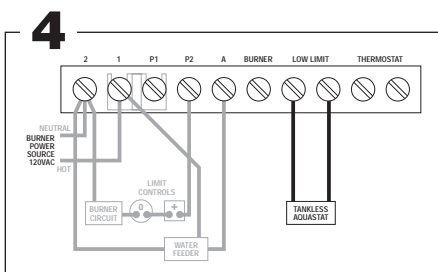

Connect "LOW LIMIT" terminals on CycleGard control to the terminals on the tankless aquastat.

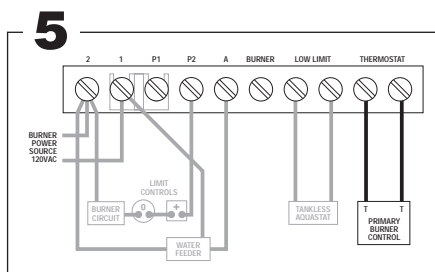

Connect "THERMOSTAT" terminals on CycleGard control to T-T terminals on burner primary control.

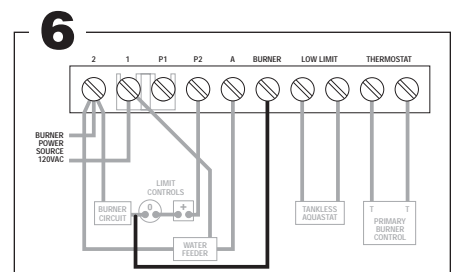

Connect "BURNER" terminal on the CycleGard control to the orange burner wire (120VAC) located under the oil burner transformer. See opposite page for schematic wiring diagram and additional SmartCycle description.



CycleGard Intermittent Level Test Feature

To provide added protection to today's smaller boilers, the CycleGard low water cut-off is equipped with an Intermittent Level Test feature. This feature removes power from the burner circuit for 90 seconds at 10 minute intervals to allow foam and volatile water to settle giving a very accurate measurement of the boiler water level.



The optional SmartCycle feature allows the control to initiate the test time sequence only when the burner fires enabling full 10

minute run times. On CGT450 models (designed for boilers equipped with tankless coils), SmartCycle suspends the Intermittent Level Test during a call for domestic hot water allowing the boiler to deliver its full BTU capacity to the production of hot water.

Burner Connection Model CG450 and CGT450

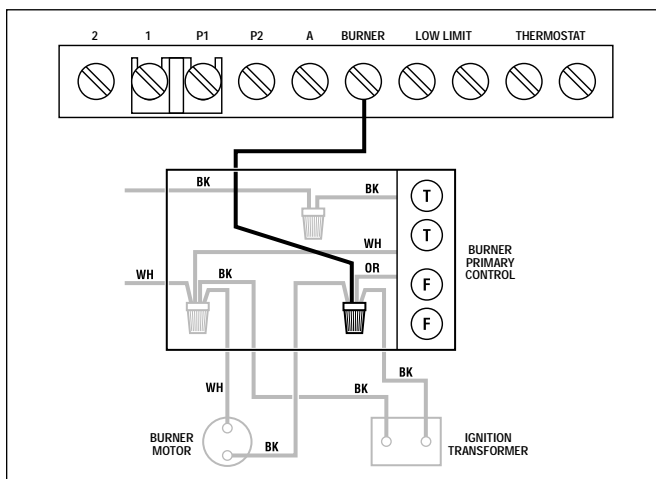

Operating Instructions

NOTE

For proper low water cut-off operation, the boiler should be cleaned at initial installation and periodically thereafter. Refer to the boiler manufacturer's instructions for cleaning procedures.

OPERATING TEST PROCEDURE

1. After installation, bring the boiler water to a safe operating level, turn on power and set the thermostat to call for heat. The amber LED lamp should be off. **The boiler will fire immediately.**
2. *Slowly* lower the boiler water to a point below the probe. The amber LED lamp on the control will light. The lamp may begin to flicker with the bouncing water level. Stop draining the boiler when the lamp glows steadily. NOTE: The water should not be lowered beyond a visible point in the gauge glass.
3. The boiler will shut down within 15 seconds.

IF BURNER DOES NOT SHUT DOWN IN LOW WATER

1. Check terminal block wiring to insure that all connections are correct.
2. Check the probe installation to insure that there is 1/4" clearance from any surface within the boiler or pipe. (Refer to Step 3 on page 1 of this instruction sheet.)
3. Clean the boiler in accordance to the manufacturer's instructions. Machining oils, grease, rust and other contaminants in the boiler water can cause foaming or surging and make a low water condition difficult to detect during burner operation.

IF THE AMBER LED LAMP IS ON

The amber LED lamp indicates that the water is below the probe. If the gauge glass shows that the water is at the correct operating level and the amber LED is lit check the following:

1. Check for plugged gauge glass.
2. Make sure probe lead wire is properly secured to the terminal.
3. Check for proper ground between probe and boiler shell. Excessive use of Teflon tape or sealing compound may isolate the probe from the boiler shell.
4. Remove probe and examine for oily residue. Clean probe with steel wool and skim boiler.

IF THE GREEN LED LIGHT IS ON

The green LED lamp indicates that the control is in a 90 second test mode. The burner does not fire during the test period. See Intermittent Level Test Feature on this page for more details.

Maintenance

To ensure optimum performance remove and inspect probe annually. Clean any sediment or scale from the probe using a scouring pad or steel wool. Re-install the probe and perform the Operating Test Procedure described above.

VXT WATER FEEDER



The Safgard VXT water feeder (available separately) is fully programmable to accommodate any steam system. By simply arranging a series of rocker switches the delay time before feed can be adjusted to allow condensate to return to the boiler. Settings from 30 seconds to ten min-

utes are available. The amount of feed can also be set from one to five gallons. If necessary, a second delay/feed cycle is permitted. If the low water condition still exists after the second cycle the control will lock-out to prevent flooding of the system.

PROBES

Test Pressure: 1000 PSI, All Models

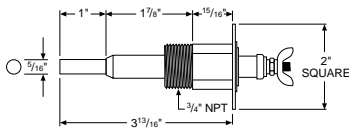

EL1214 – STANDARD MODEL – 3/4" NPT
For 1/2", order Model No. EL-1220

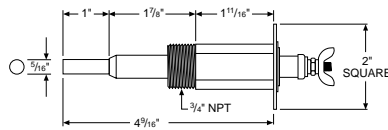

EL1214-P – 3/4" NPT



**EL1214-R
REMOTE PROBE**

THE PROBE MAKES THE DIFFERENCE

The probe used in all Hydrolevel controls offers you distinctive advantages. Unlike float devices, there are no moving parts to wear stick, or "hang-up" in the harsh boiler environment.

A stuck or "hung-up" float can cause dangerous low water conditions. And if suddenly released, a float can feed cold water into overheated tubes or plates and cause explosive results.

The Hydrolevel control has no float bowl so sediment cannot collect. The reliable solid state circuitry and low maintenance probe are designed to provide years of troublefree operation.

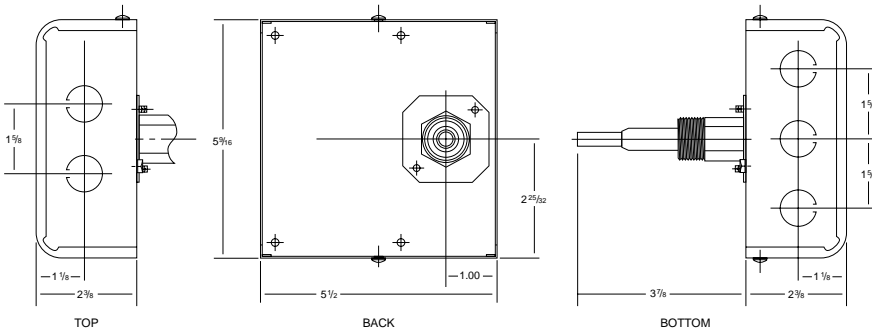

- MAXIMUM PRESSURE:** 15 PSI
- INPUT VOLTAGE:** 120 VAC, 60 HZ
- SWITCH RATINGS:** 5.8 FLA, 34.8 LRA
- SWITCH CONTACTS:** SPDT
- ALARM CIRCUIT:** 125 VA @ 120 VAC
Pilot Duty



LIMITED MANUFACTURER'S WARRANTY

We warrant products manufactured by Hydrolevel Company to be free from defects in material and workmanship for a period of two years from the date of manufacture or one year from the date of installation, whichever occurs first. In the event of any claim under this warranty or otherwise with respect to our products which is made within such period, we will, at our option, repair or replace such products or refund the purchase price paid to us by you for such products. In no event shall Hydrolevel Company

be liable for any other loss or damage, whether direct, indirect, incidental or consequential. This warranty is your EXCLUSIVE remedy and shall be IN PLACE OF any other warranty or guarantee, express or implied, including, without limitation, any warranty of MERCHANTABILITY or fitness for a particular purpose. This warranty may not be assigned or transferred and any unauthorized transfer or assignment thereof shall be void and of no force or effect.

HYDROLEVEL COMPANY

P.O. Box 1847
New Haven, CT 06508
Phone: (203) 776-0473
FAX: (203) 773-1019